

### HZ32 Connector

p.1

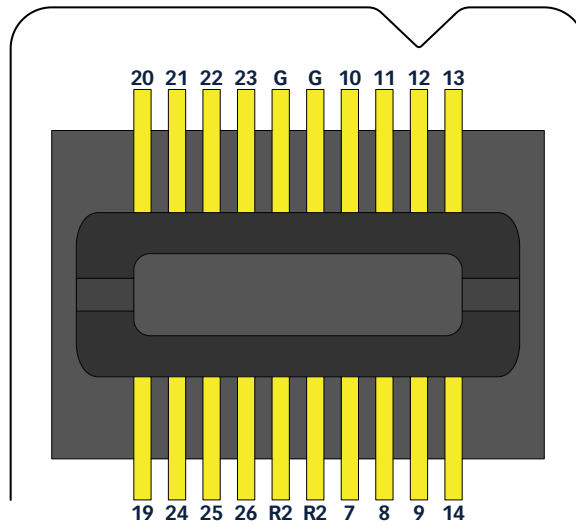
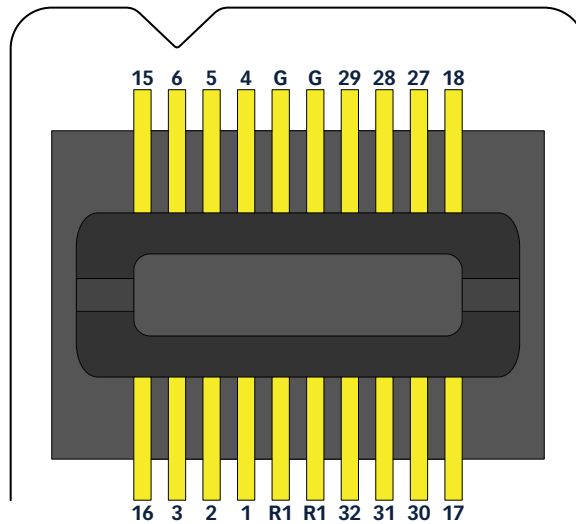

G = Ground  
R = Reference

## SPECIFICATIONS

**Connector** ZIF Clip® Connector, 32 Channels

**Mating Connector** ZIF Clip® Headstage, 32 Channels

Note: For proper grounding, please use the correct wiring configuration for your probe

### Reference Channel Configuration (3 wires, 1 jumper)

p.2

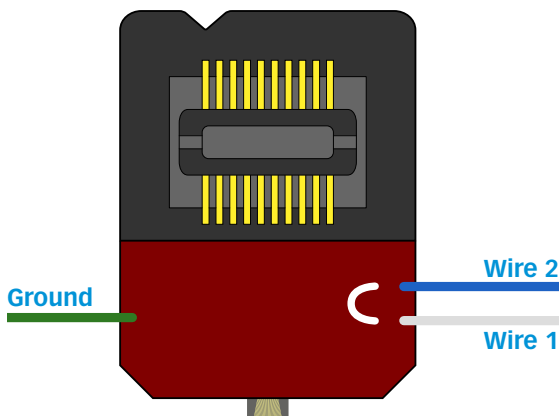
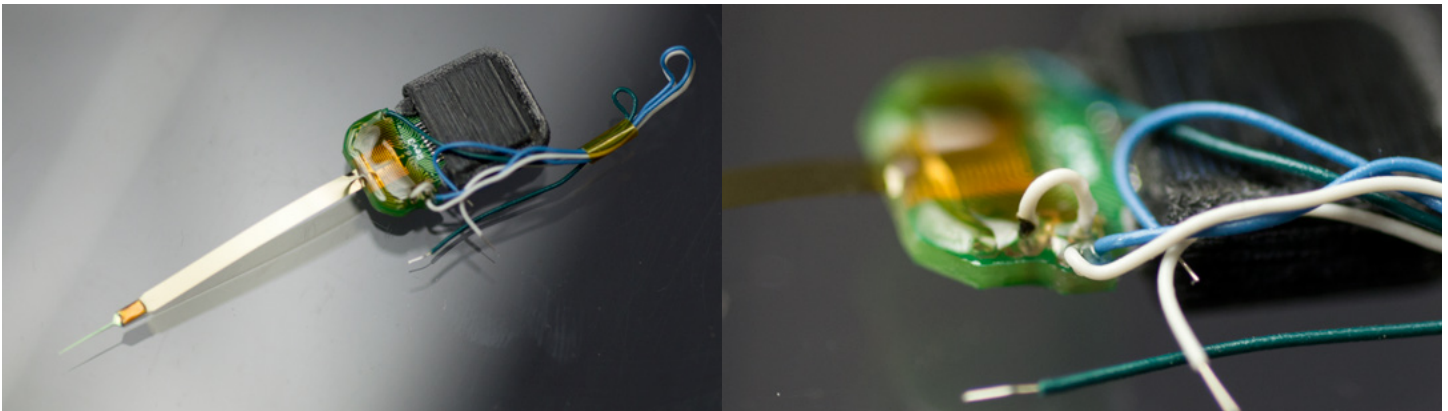

The HZ32 Gen. 4 package has 1 insulated wire loop jumper (see above) and 3 colored insulated wires. The Ground wire is green. **Please read fully before making your desired changes - it may not be possible to reconnect the wire loops once they have been cut.**

NeuroNexus recommends taking one of the following reference configuration options. **You must choose one option (see below) and act accordingly or a ground loop may form.**

**If your probe has a Probe Reference site, and you want to use it,** follow these instructions:

1. **Cut** Wire 1 (white)
2. Channel R1 serves as the Probe Reference. Wire 2 (blue) connects an external reference to Channel R2; if you do not want to use an external reference, cut Wire 2.

**To use only 1 external reference source,** follow these instructions:

1. **Cut** the Wire Reference Jumper
2. Tie Wire 1 and Wire 2 together. Channels R1 and R2 both serve as the external reference.

**To use 2 external reference sources,** follow these instructions:

1. **Cut** the Wire Reference Jumper
2. Channels R1 and R2 serve as independent external references. Wire 1 (white) feeds into Channel R1, and Wire 2 (blue) feeds into Channel R2.

Note: For proper grounding, please use the correct wiring configuration for your probe

### Reference Channel Configuration (2 Wires, 2 Jumpers)

p.3

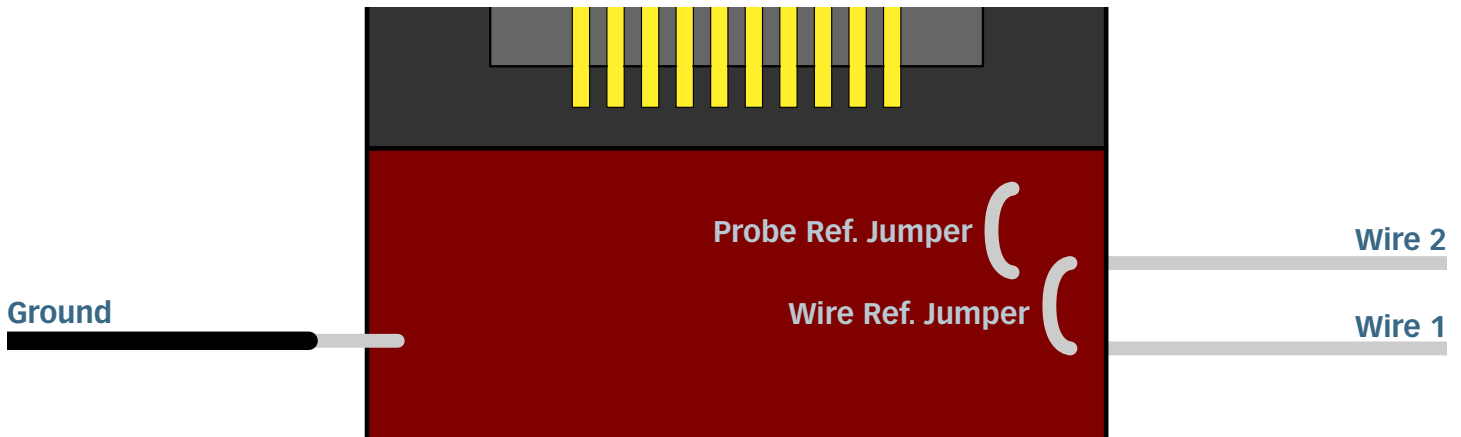

The HZ32 package has 2 wire jumpers (see above). Wire 1 and Wire 2 correspond to the R1 and R2 pins respectively on the Zif Clip® connector. Depending on how these loops are cut, different reference channel configurations can be obtained. **Please read fully before making your desired changes - it may not be possible to reconnect the wire loops once they have been cut.**

NeuroNexus recommends taking one of two reference configuration options. **You must choose one option (see below) and act accordingly. Using a probe as-is may create ground loops.** Never use an external wire reference through Wire 1 with an active Probe Reference site, as this creates a ground loop.

- A** **To use the Probe Reference site**, pursue **one** of the following two options:
1. To feed Probe Reference into both R1 and R2 channels, cut Wires 1 and 2 and leave the jumpers uncut.
  2. To feed Probe Reference to R1 and an external reference to R2 (via Wire 2), cut Wire 1 and the Wire Reference Jumper.
- B** **To disable the Probe Reference site**, cut the **Probe Reference Jumper**, then take **one** of the following two actions:
1. For independent wire reference signals, cut the Wire Reference Jumper. Wire 1 feeds into the R1 channel, and Wire 2 feeds into the R2 channel.
  2. For one wire reference signal into both R1 and R2 channels, cut either Wire 1 or Wire 2.

## Reference Channel Configuration (2 Wires, No Jumpers)

p.4

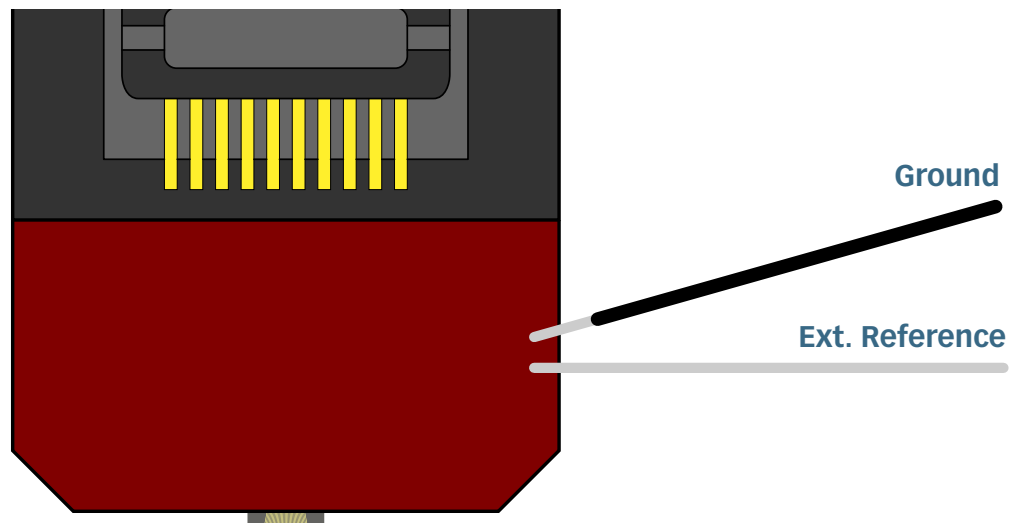

**IMPORTANT:** Check our catalog to see if your probe model has a probe reference (PR) site.

**If your design has a PR site,** and you did not request that the PR site be disconnected:

1. Cut the External Reference wire
2. Make sure that the PR site is completely implanted

If your probe has a PR site, all Reference channels (see p.1) will function as the probe reference. If your probe does not have a PR site, or has the PR site disconnected, all Reference channels will function as the external reference.



A1x32

p.5

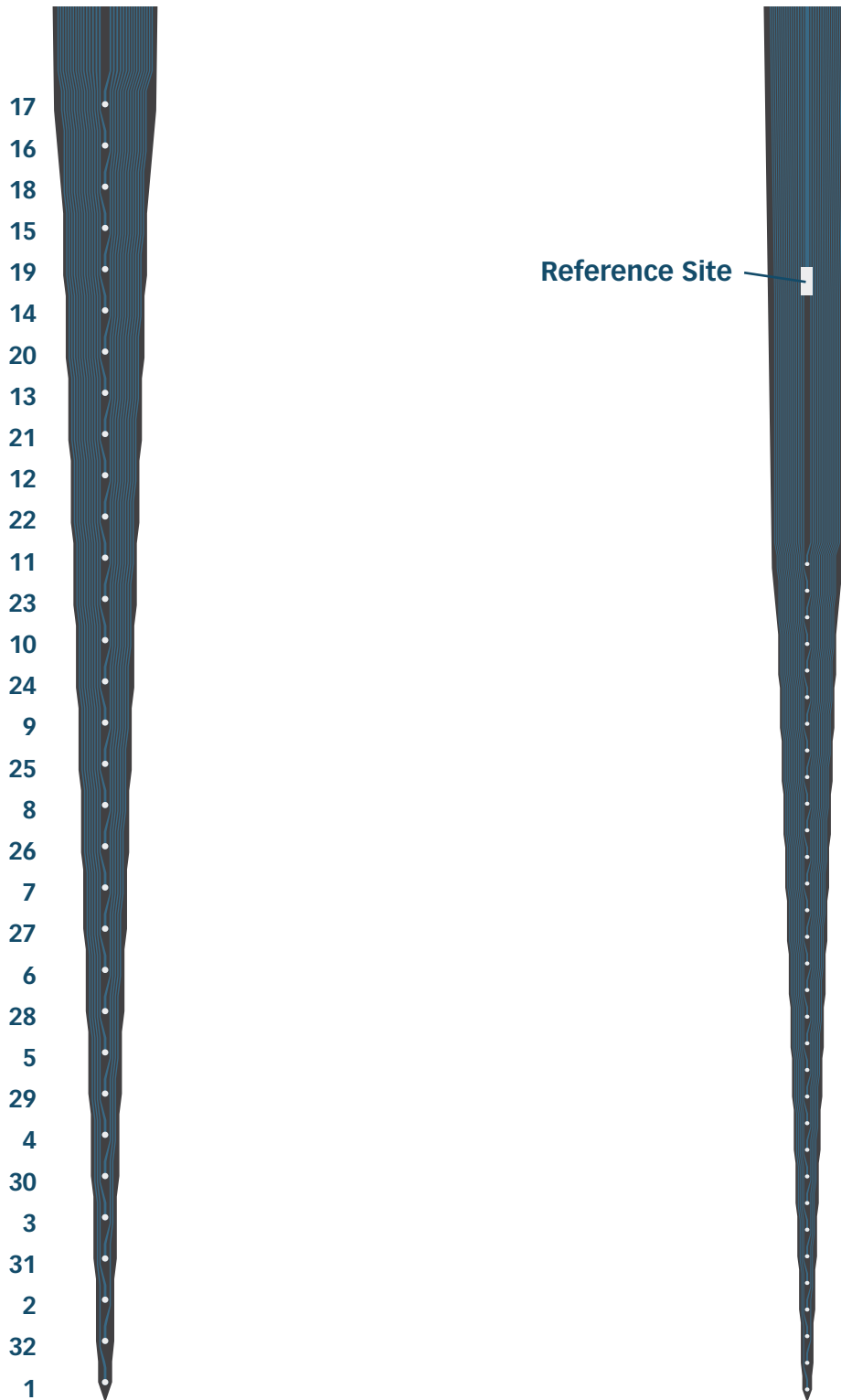



### A1x32-Edge

p.6

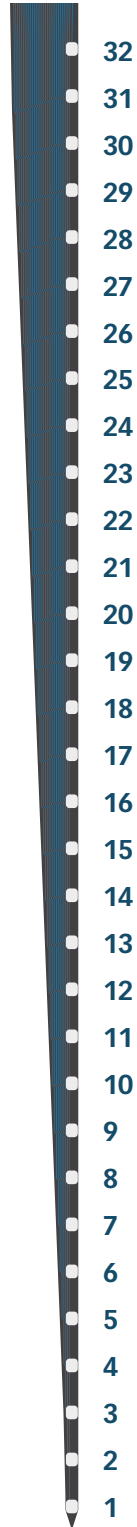



### A1x32-Poly2

p.7

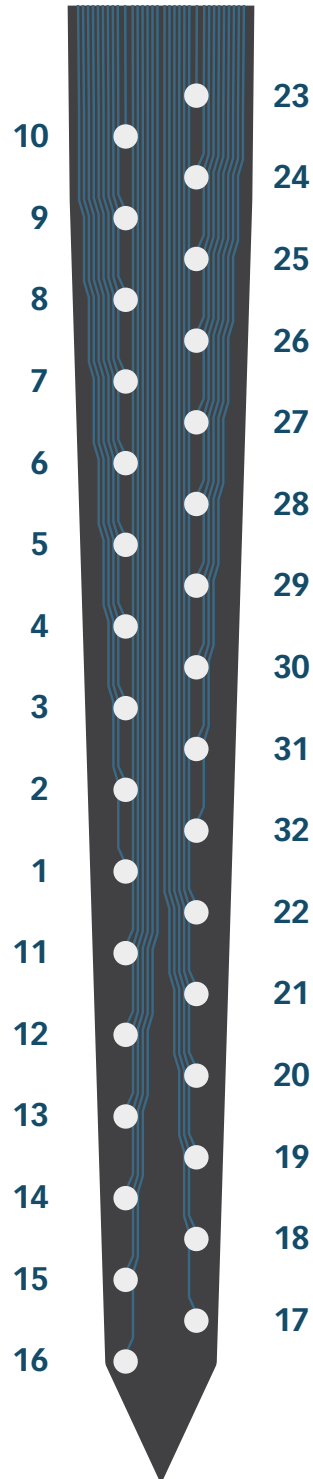



A1x32-Poly3-5mm-25s-177  
A1x32-Poly3-10mm-25s-177

p.8

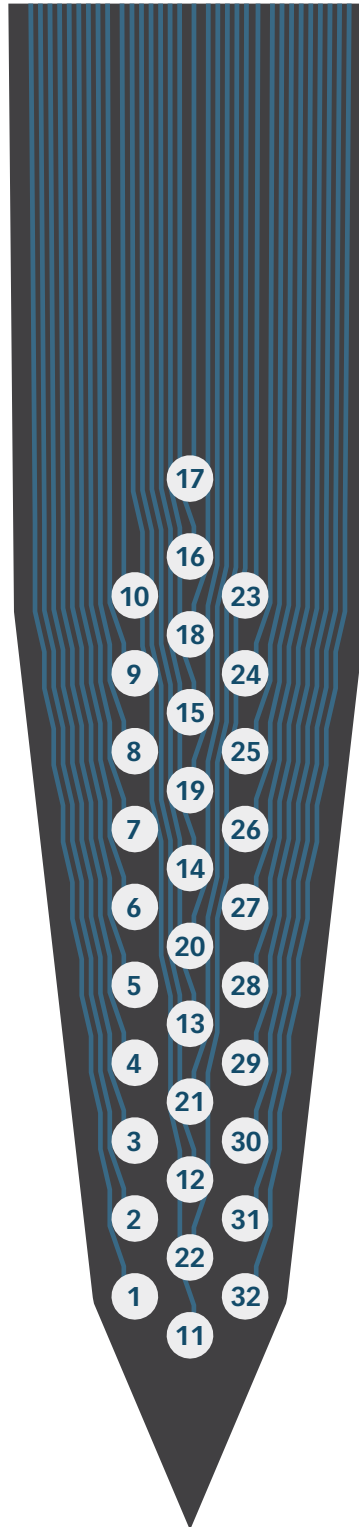





A1x32-Poly3-6mm-50-177

p.9

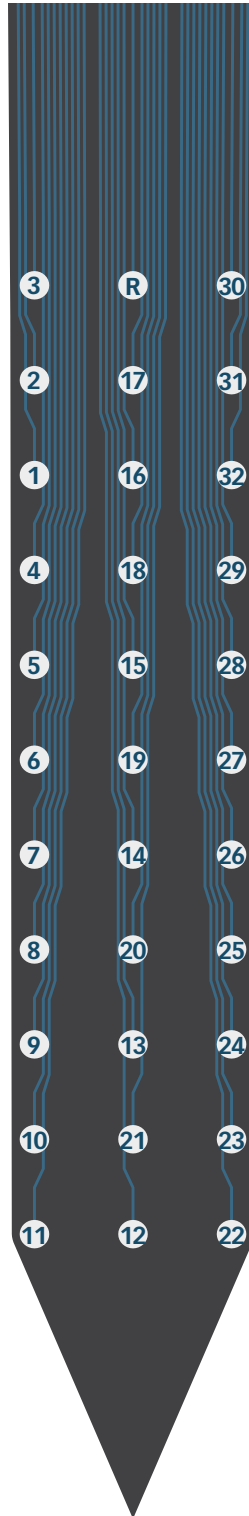

A1x32-Poly3-10mm-50-177

p.10

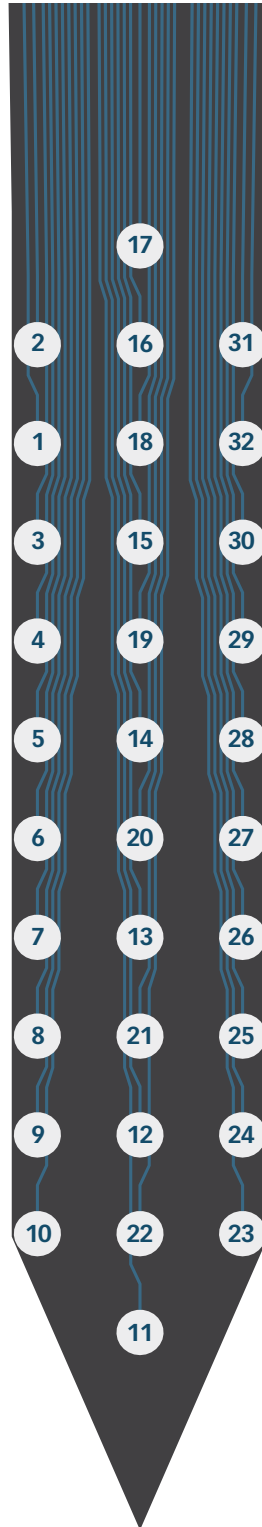



A2x16

p.11

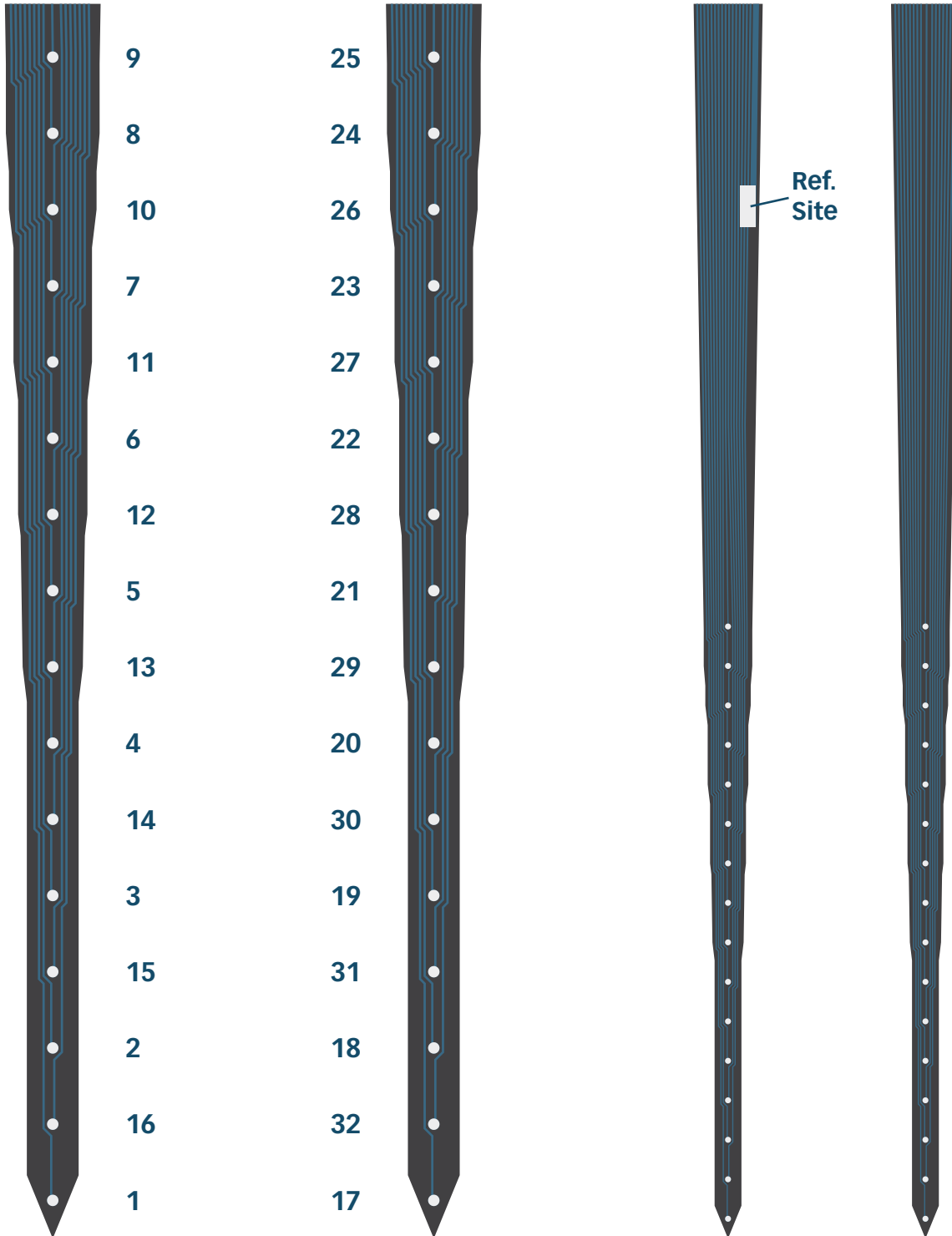



A4x8

p.12

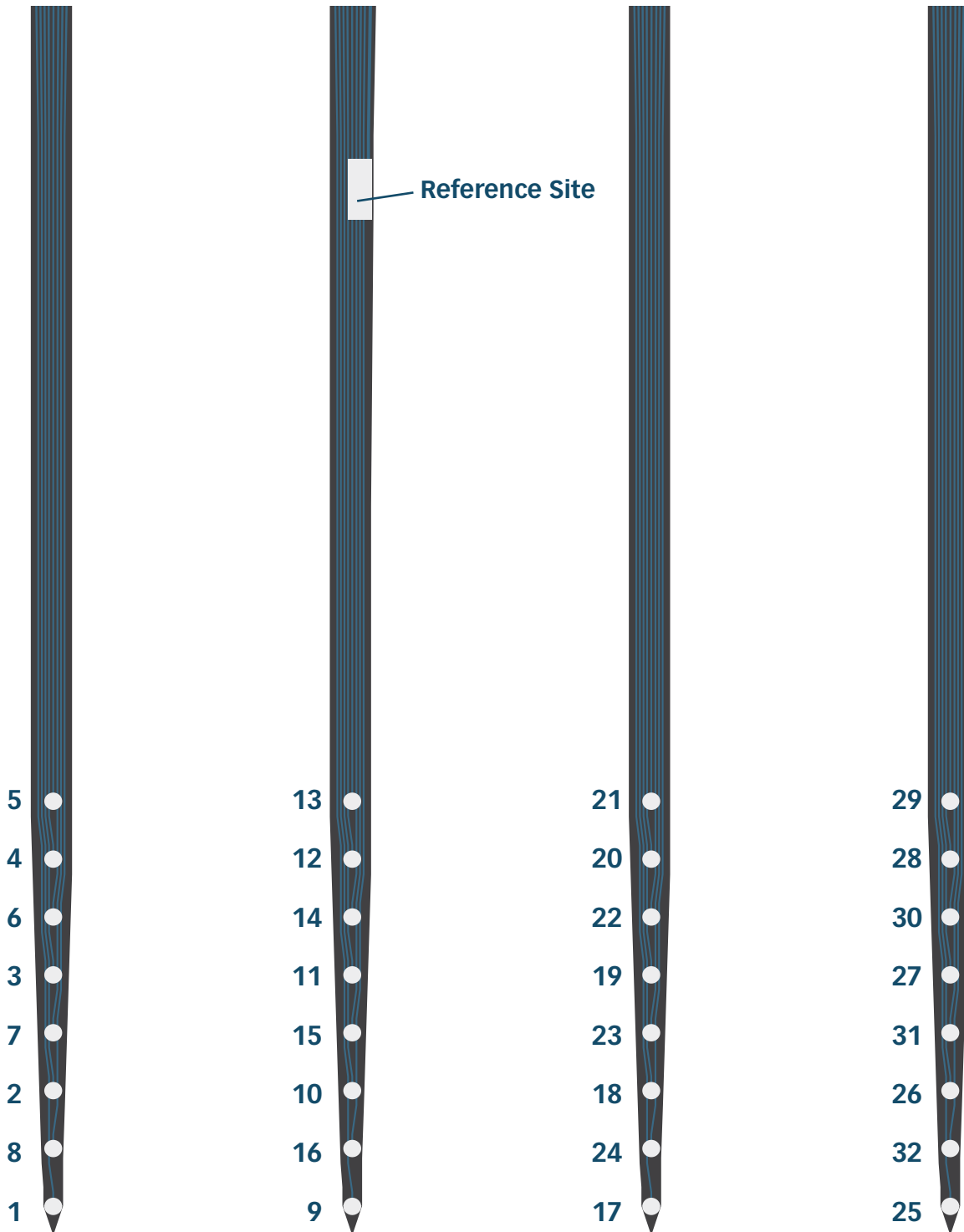



### A4x8-10mm-50-200-VAR

p.13

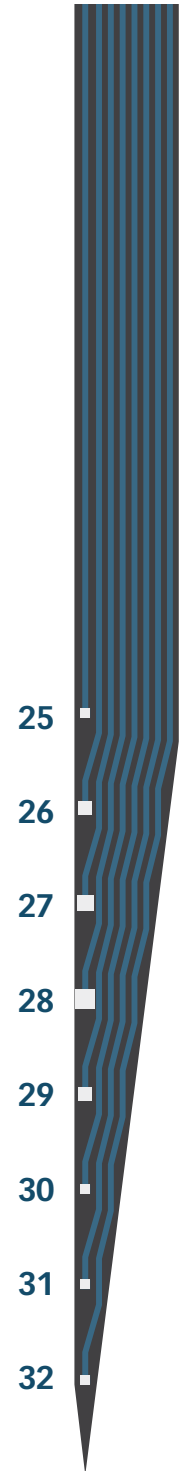
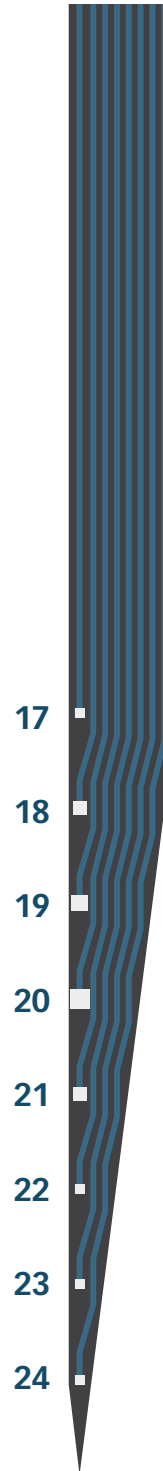
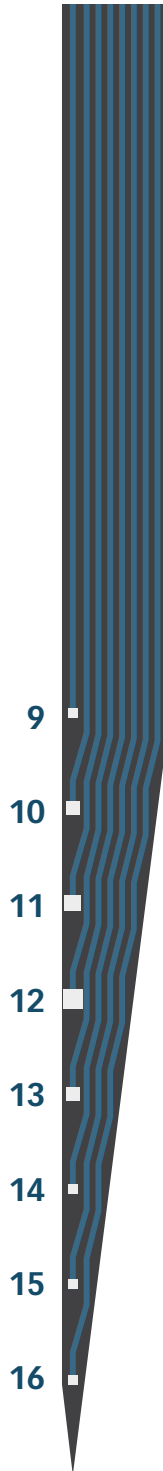
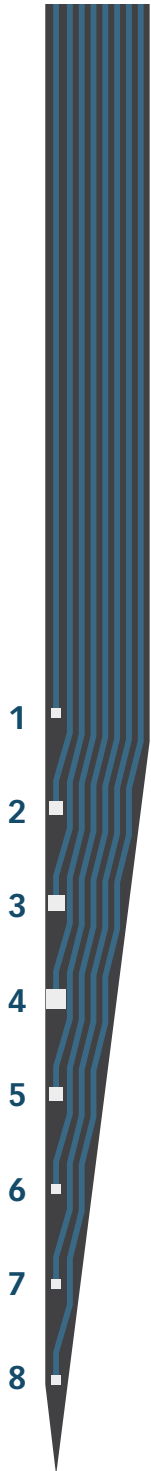



### A4x2-tet

p.14

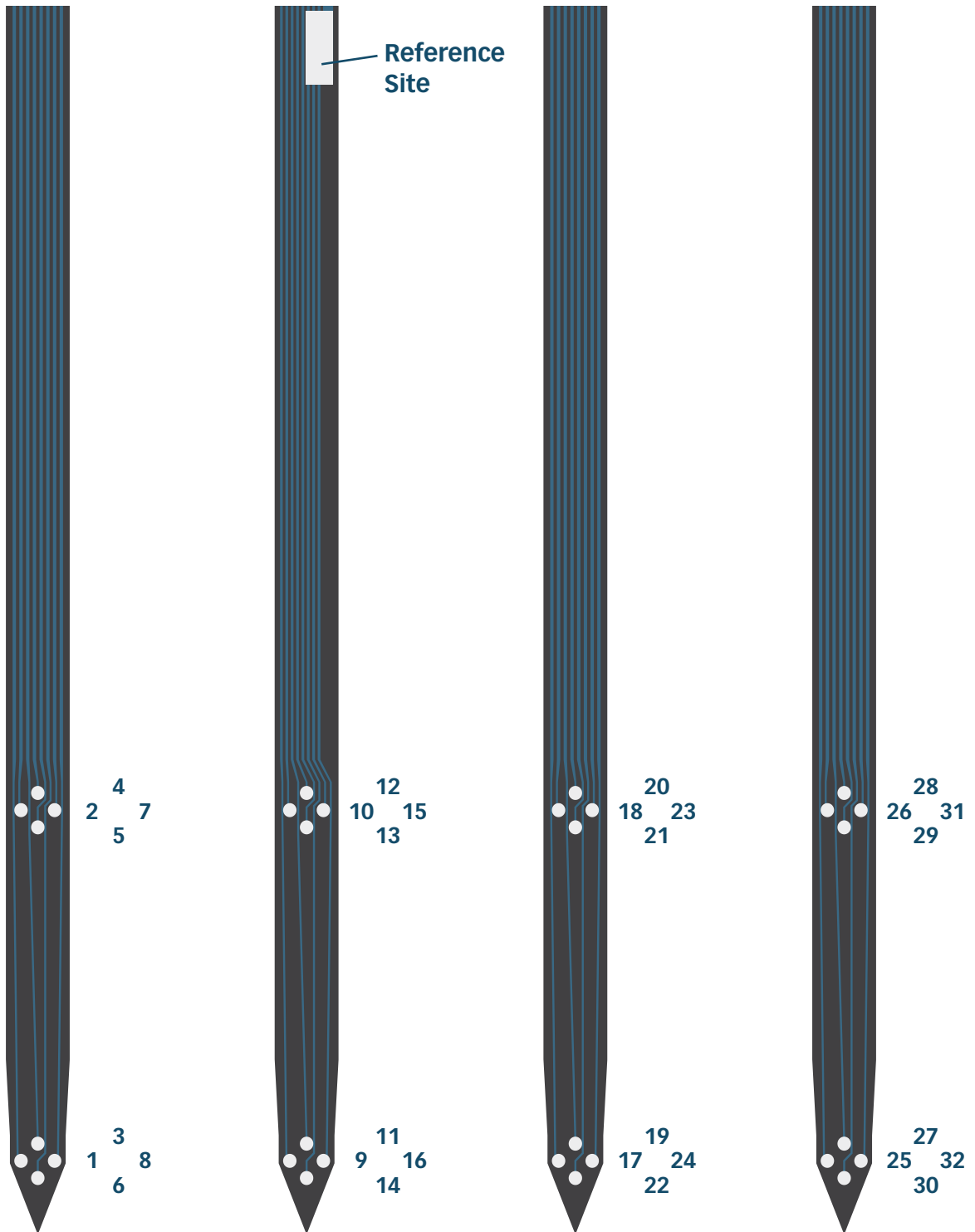



### Buzsaki32

p.15

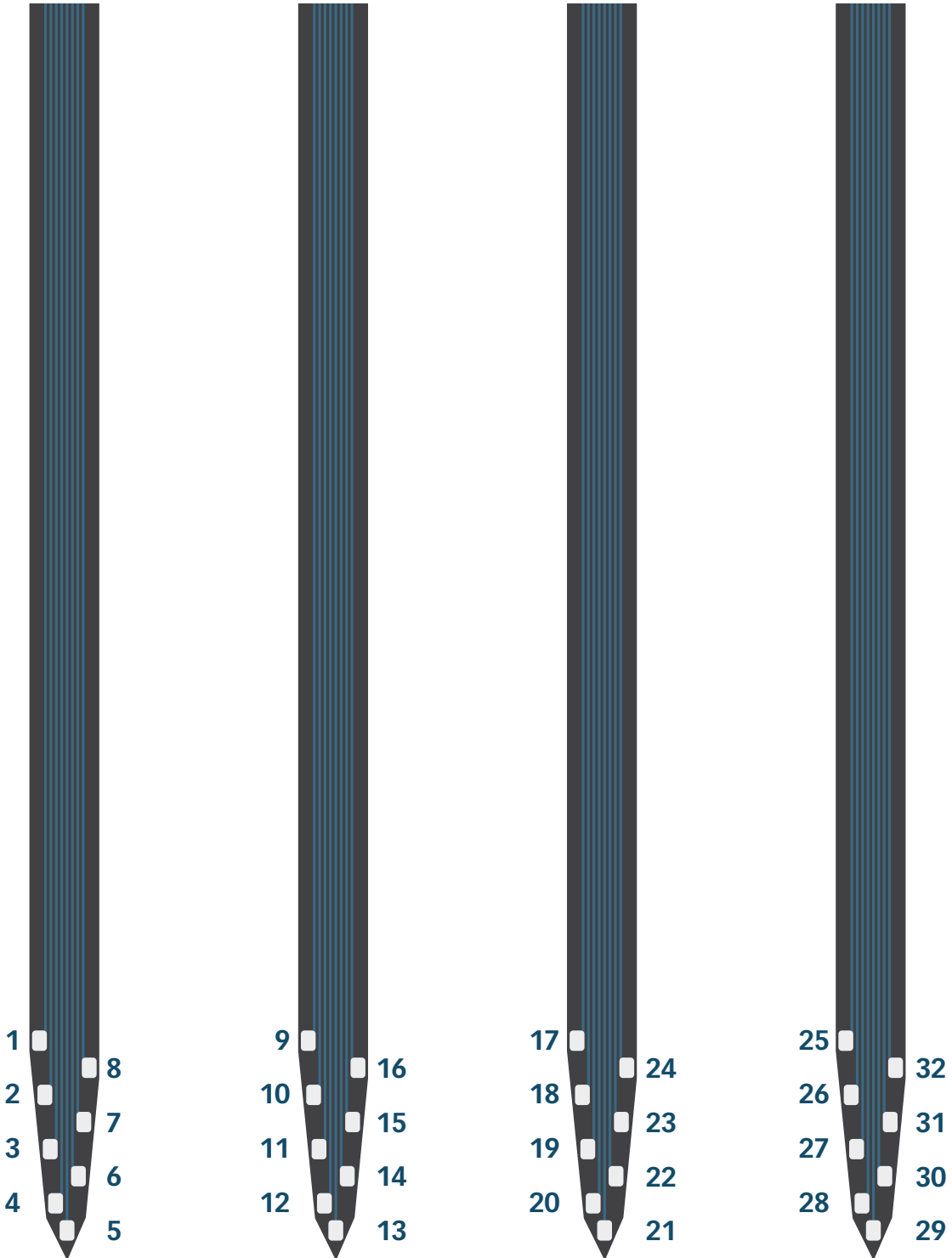



A8x4

p.16

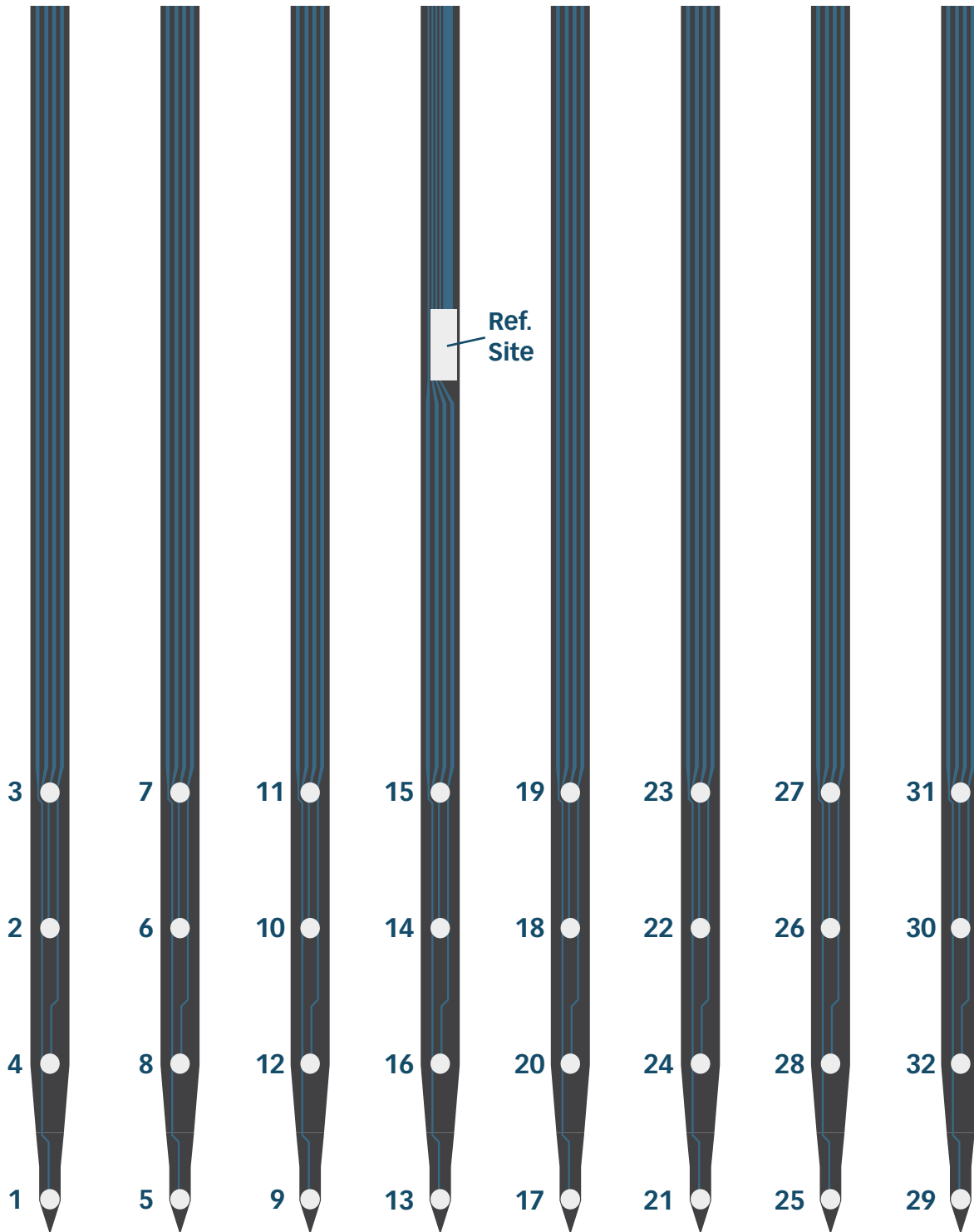





### A8x1-tet

p.17

